

NOTE : MINIMUM DISTANCE BETWEEN FLOATS IS 50mm

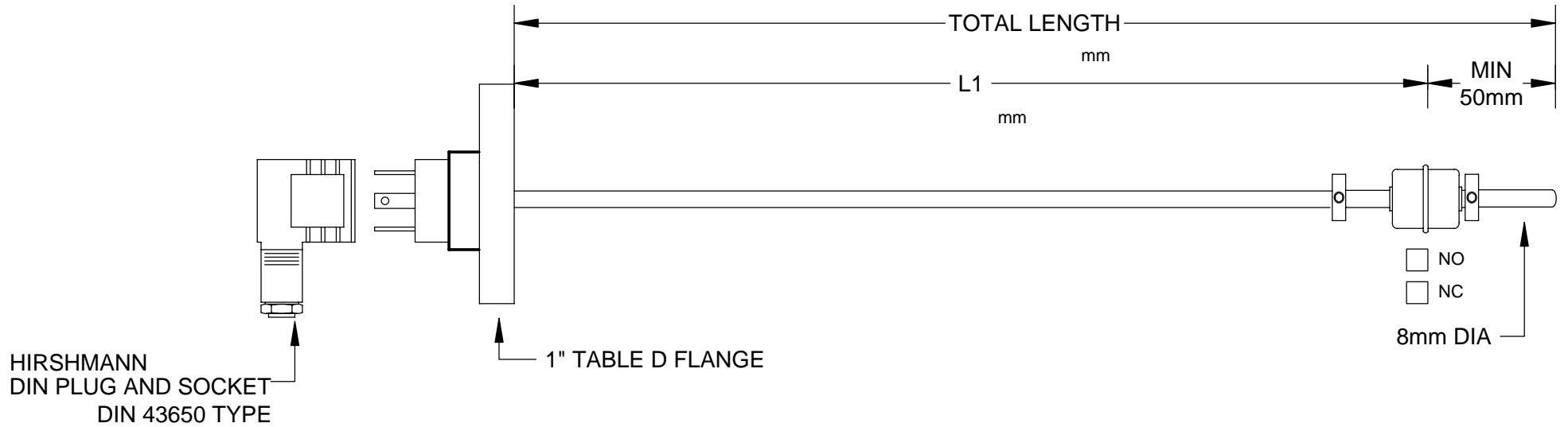

- STANDARD - NO or NC CONTACT RATED AT 32V AC/DC @ 500mA RESISTIVE LOAD
- OPTION - NO or NC CONTACT RATED AT 250V AC/DC @ 500mA RESISTIVE LOAD
- CHANGE OVER CONTACT RATED @ 250mA RESISTIVE LOAD

FLOAT DIMENSIONS

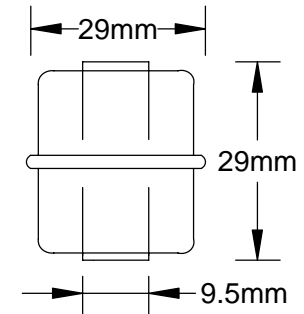

PROCESS CAPABILITIES

- STAINLESS STEEL CONSTRUCTION
- UP TO 5 FLOATS PER ASSEMBLY MAXIMUM LENGTH 1800mm
- INDIVIDUAL OR COMMON CIRCUIT WIRING
- SPECIAL THREADS AND LENGTHS AVAILABLE
- SPECIFIC GRAVITY 0.7
- TEMPERATURE RATING 120'C MAXIMUM
- PRESSURE RATING :10 kg/cm2 MAXIMUM
- FLANGE MOUNT MULTI -LEVEL ASSEMBLY
- 29mm DIAMETER 304 STAINLESS STEEL FLOAT

TEMPERATURE CONTROLS PTY LTD

QUALITY ENDORSED COMPANY
Certificate No:QEC 14412
AS/NZS 9001:2008

CONDITIONS

THIS DRAWING IS OUR EXCLUSIVE PROPERTY AND MUST NOT BE COPIED OR HANDED TO ANY OTHER PARTIES WITH OUT WRITTEN PERMISSION. IT SHALL BE RETURNED UPON REQUEST

SYDNEY: 7 YAMMA ST SEFTON , NSW 2162
PHONE: (02) 9721 8644 FAX : (02) 9738 9339
MELBOURNE: 8/280 Whitehall St YARRAVILLE, VIC 3013
PHONE: (03) 9687 0000 FAX : (03) 9687 1900
BRISBANE: 28A/125 Kerry Road, Archerfield Qld 4108
PHONE: (07) 3373 8424 fax: (07) 3373 8067
EMAIL: sales@temperature.com.au

TITLE

SIZE : A4	DATE : 13/07/15	DWG NO :SD 6019
SCALE : NTS	DRAWING BY R.B	REV : 01